

# Engineering Data

## Compact Four-way Cassette VRF IDU



MIH15Q4CHN18

MIH45Q4CHN18

MIH22Q4CHN18

MIH56Q4CHN18

MIH28Q4CHN18

MIH63Q4CHN18

MIH36Q4CHN18

# Compact Four-way Cassette

<b>1 Specifications .....</b>	<b>4</b>
<b>2 Dimensions .....</b>	<b>6</b>
<b>3 Unit Placement .....</b>	<b>7</b>
<b>4 Piping Diagram .....</b>	<b>8</b>
<b>5 Wiring Diagram .....</b>	<b>9</b>
<b>6 Capacity Tables.....</b>	<b>10</b>
<b>7 Electrical Characteristics.....</b>	<b>11</b>
<b>8 Sound Levels .....</b>	<b>12</b>
<b>9 Temperature and Airflow Distributions .....</b>	<b>14</b>

## 1 Specifications

Table 1.1: MIH15(22,28,36)Q4CHN18 specifications

Model			MIH15Q4CHN18	MIH22Q4CHN18	MIH28Q4CHN18	MIH36Q4CHN18
Power supply			1-phase, 220-240V, 50/60Hz			
Cooling <sup>1</sup>	Capacity	kW	1.5	2.2	2.8	3.6
		kBtu/h	5.1	7.5	9.6	12.3
	Power input	W	14	14	16	18
Heating <sup>2</sup>	Capacity	kW	1.8	2.4	3.2	4.0
		kBtu/h	6.1	8.2	10.9	13.7
	Power input	W	14	14	16	18
Fan motor type			DC			
Indoor coil	Number of rows		1	1	1	2
	Tube pitch × row pitch	mm	18×10.72			
	Fin spacing and type	mm	1.2 Hydrophilic aluminum			
	Tube OD and type	mm	Φ5 Inner-groove			
	Dimensions (L×H×W)	mm	438×180×438			
	Number of circuits		1	1	1	2
Air flow rate <sup>3</sup> (0Pa)		m <sup>3</sup> /h	450/425/400/370/345/320/295		510/480/455/425/395/370/340	530/500/470/440/405/375/345
Sound pressure level <sup>4</sup> (0Pa)		dB(A)	29/28/27/27/26/26/25		30/29/28/27/26/26/25	31/30/29/28/27/26/25.5
Sound power level <sup>5</sup> (0Pa)		dB(A)	40/39/39/39/38/38/38		42/41/40/39/39/38/38	42/40/39/38/38/38/38
Air flow rate <sup>3</sup> (30Pa)		m <sup>3</sup> /h	670/630/590/549/509/470/435		690/649/610/565/525/485/450	730/685/640/599/555/510/475
Sound pressure level <sup>4</sup> (30Pa)		dB(A)	38/36/34/33/31/27/26		39/37/36/33/32/29/27	40/38/36/34/32/29/27
Sound power level <sup>5</sup> (30Pa)		dB(A)	47/47/46/45/44/44/43		48/47/47/46/45/44/43	50/49/48/47/46/45/43
Main body	Net dimensions <sup>6</sup> (W×H×D)		mm 575×235×638			
	Packed dimensions (W×H×D)		mm 690×285×690			
	Net/Gross weight		kg 13.0/15.0			14.0/16.0
Panel	Net dimensions (W×H×D)		mm 620×65×620			
	Packed dimensions (W×H×D)		mm 680×80×665			
	Net/Gross weight		kg 2.4/3.2			
Refrigerant type			R410A/R32			
Design pressure (H/L)		MPa	4.4/2.6			
Pipe connections	Liquid/Gas pipe		mm Φ6.35/Φ12.7			
	Drain pipe		mm OD Φ25			

Notes:

- Indoor temperature 27°C DB, 19°C WB; outdoor temperature 35°C DB; equivalent refrigerant piping length 5m with zero level difference.
- Indoor temperature 20°C DB; outdoor temperature 7°C DB, 6°C WB; equivalent refrigerant piping length 5m with zero level difference.
- Air flow rate are from the highest speed to the lowest speed, total 7 rates for each model.
- Sound pressure level is from highest level to lowest level, total 7 levels for each model. Sound pressure level is measured 1.4m below the unit in a semi-anechoic chamber.
- Sound power level is from highest level to lowest level, total 7 levels for each model.
- Unit body dimensions given are the largest external dimensions of the unit, including hanger attachments.

Table 1.2: MIH45(56,63)Q4CHN18 specifications

Model			MIH45Q4CHN18	MIH56Q4CHN18	MIH63Q4CHN18
Power supply			1-phase, 220-240V, 50/60Hz		
Cooling <sup>1</sup>	Capacity	kW	4.5	5.6	6.3
		kBtu/h	15.4	19.1	21.5
	Power input	W	25	35	50
Heating <sup>2</sup>	Capacity	kW	5.0	6.3	7.1
		kBtu/h	17.1	21.5	24.2
	Power input	W	25	35	50
Fan motor type			DC		
Indoor coil	Number of rows		2	3	3
	Tube pitch × row pitch	mm	18×10.72		
	Fin spacing and type	mm	1.2 Hydrophilic aluminum		
	Tube OD and type	mm	Φ5 Inner-groove		
	Dimensions (L×H×W)	mm	438×180×438		
	Number of circuits		2	3	3
Air flow rate <sup>3</sup> (0Pa)	m <sup>3</sup> /h	640/605/570/530/ 495/460/425	810/765/720/670/ 625/580/535	905/855/805/755/ 705/655/605	
Sound pressure level <sup>4</sup> (0Pa)	dB(A)	36.5/35/33/31/29/28/26.5	39/38/37/36/35/34/32	43/42/40/38/36/35/33.5	
Sound power level <sup>5</sup> (0Pa)	dB(A)	44/44/43/42/41/41/41	48/46/45/43/42/42/41	51/50/48/46/45/44/42	
Air flow rate <sup>3</sup> (30Pa)	m <sup>3</sup> /h	810/760/715/665/615/570/ 530	920/865/810/755/700/ 645/600	1020/960/900/835/775/ 715/665	
Sound pressure level <sup>4</sup> (30Pa)	dB(A)	43/41/39/37/35/32/30	45/43/41/39/37/34/32	48/46/44/42/40/38/35	
Sound power level <sup>5</sup> (30Pa)	dB(A)	53/52/51/50/48/47/46	56/55/54/52/51/50/48	59/58/56/55/54/52/51	
Main body	Net dimensions <sup>6</sup> (W×H×D)	mm	575×235×638		
	Packed dimensions (W×H×D)	mm	690×285×690		
	Net/Gross weight	kg	14.0/16.0	15.0/17.0	
Panel	Net dimensions (W×H×D)	mm	620×65×620		
	Packed dimensions (W×H×D)	mm	680×80×665		
	Net/Gross weight	kg	2.4/3.2		
Refrigerant type			R410A/R32		
Design pressure (H/L)		MPa	4.4/2.6		
Pipe connections	Liquid/Gas pipe	mm	Φ6.35/Φ12.7		Φ9.52/Φ15.9
	Drain pipe	mm	OD Φ25		

**Notes:**

- Indoor temperature 27°C DB, 19°C WB; outdoor temperature 35°C DB; equivalent refrigerant piping length 5m with zero level difference.
- Indoor temperature 20°C DB; outdoor temperature 7°C DB, 6°C WB; equivalent refrigerant piping length 5m with zero level difference.
- Air flow rate are from the highest speed to the lowest speed, total 7 rates for each model.
- Sound pressure level is from highest level to lowest level, total 7 levels for each model. Sound pressure level is measured 1.4m below the unit in a semi-anechoic chamber.
- Sound power level is from highest level to lowest level, total 7 levels for each model.
- Unit body dimensions given are the largest external dimensions of the unit, including hanger attachments.

## 2 Dimensions

### 2.1 Unit Dimensions

Figure 2.1: Compact Four-way Cassette dimensions (unit: mm)

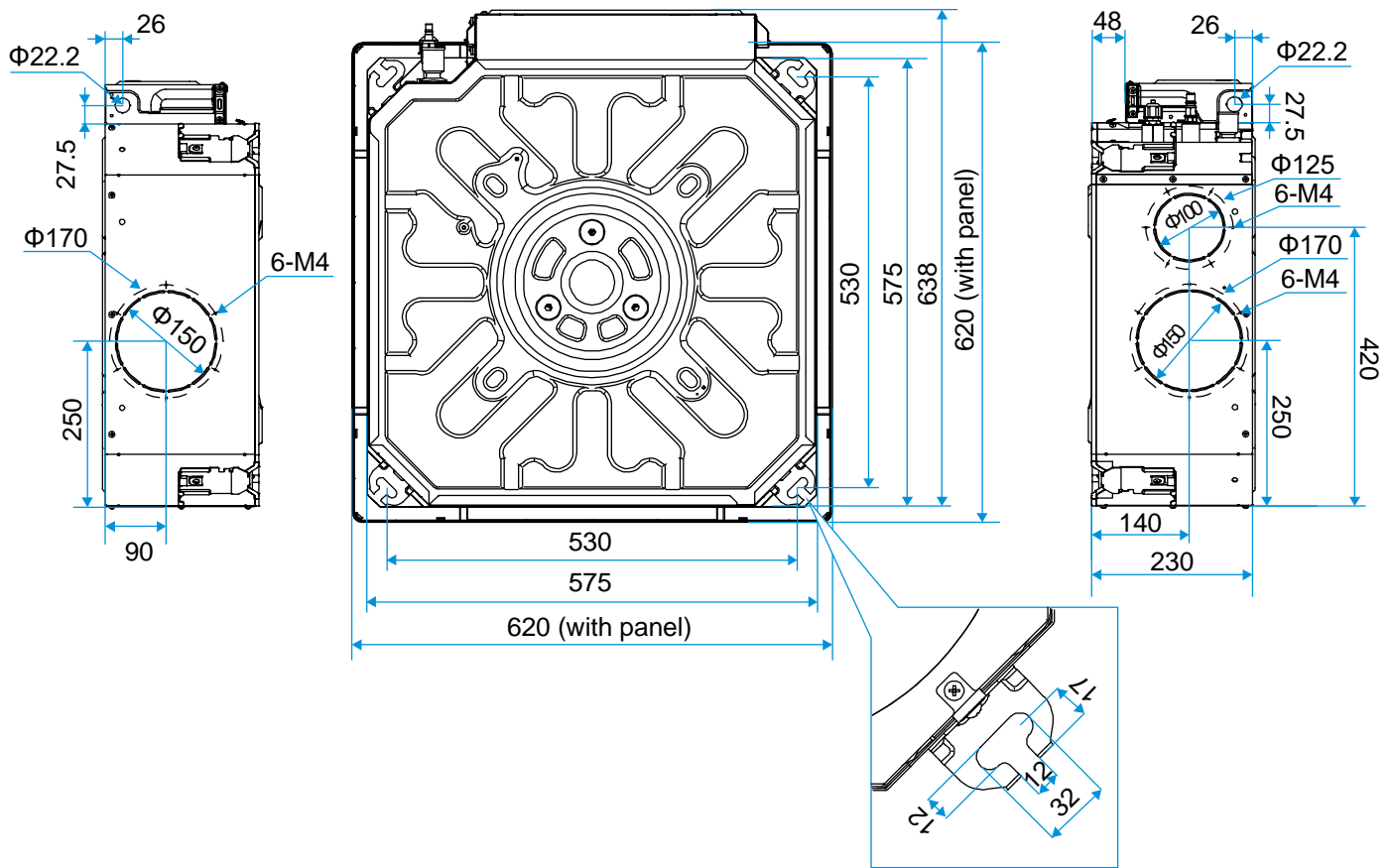

### 3 Unit Placement

#### 3.1 Placement Considerations

Unit placement should take account of the following considerations:

- Units should not be installed in the following locations:
  - A place filled with mineral oil, fumes or mist, like a kitchen.
  - A place where there are corrosive gases, such as acid or alkaline gases..
  - A place exposed to combustible gases and using volatile combustible gases such as diluent or gasoline.
  - A place where there is equipment emitting electromagnetic radiation.
  - A place where there is a high salt content in the air like a coast.
  - Do not use the air conditioner in an environment where an explosion may occur.
  - Places like in vehicles or cabin rooms.
  - Factories with major voltage fluctuations in the power supplies.
  - Other special environmental conditions.
- Units should be installed in positions where:
  - Ensure that the airflow in and out of the IDU is reasonably organized to form an air circulation in the room.
  - Ensure IDU maintenance space.
  - The nearer the drainage pipe and copper pipe are to the ODU, the lower the pipe cost is.
  - Prevent the air conditioner from blowing directly to the human body.
  - The closer the wiring to the power cabinet, the lower the wiring cost is.
  - Keep the air-conditioning return air away from the setting sun of the room.
  - Be careful not to interfere with the light tank, fire pipe, gas pipe and other facilities.
  - The IDU should not be lifted in the places like load-bearing beam and columns that affect the structural safety of the house.
  - The wired controller and the IDU should be in the same installation space; otherwise, the sampling point setting of the wired controller need to be changed.

#### 3.2 Space Requirements

Figure 3.1: Compact Four-way Cassette space requirements (unit: mm)

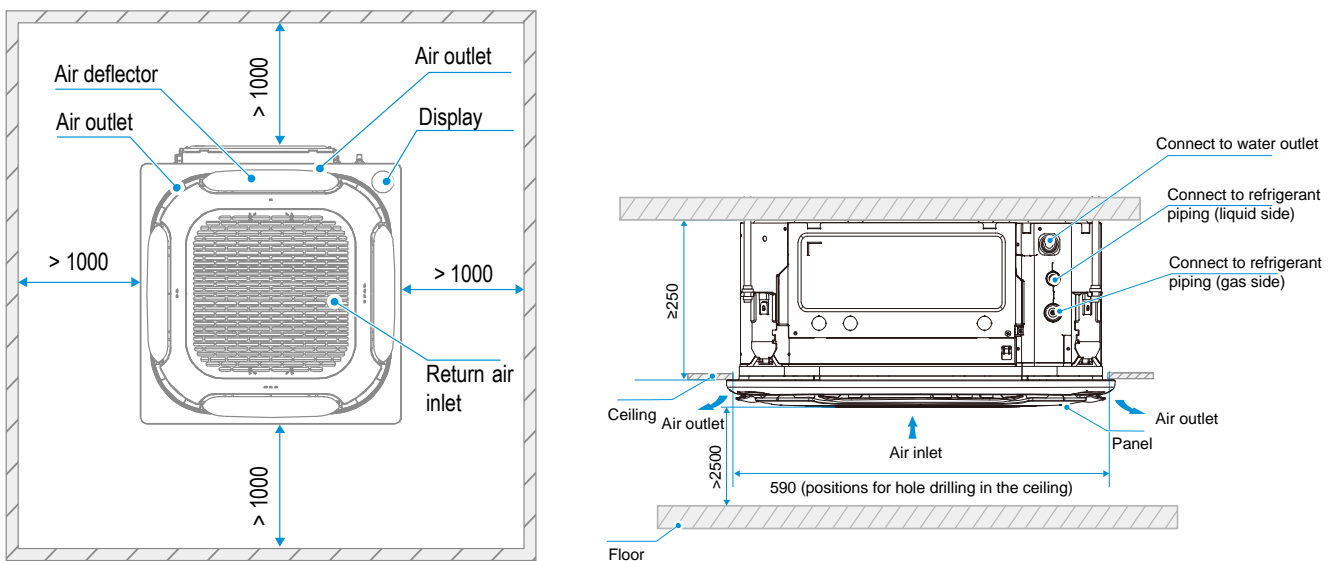

Notes:

1. The centerline of the maintenance hole should be in the same position as the centerline of the indoor unit.

## 4 Piping Diagram

Figure 4.1: Compact Four-way Cassette piping diagram

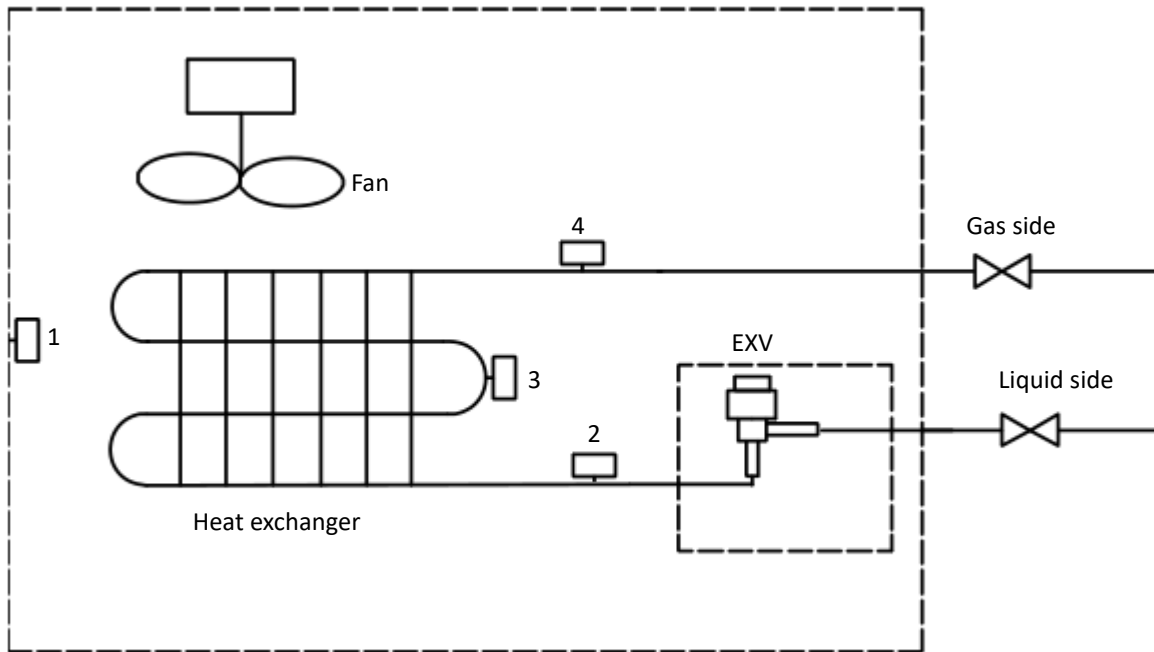

Legend		
1	T1	Indoor ambient temperature sensor
2	T2A	Indoor heat exchanger liquid side temperature sensor
3	T2	Indoor heat exchanger mid-point temperature sensor
4	T2B	Indoor heat exchanger gas side temperature sensor

## 5 Wiring Diagram

Figure 5.1: Compact Four-way Cassette wiring diagram

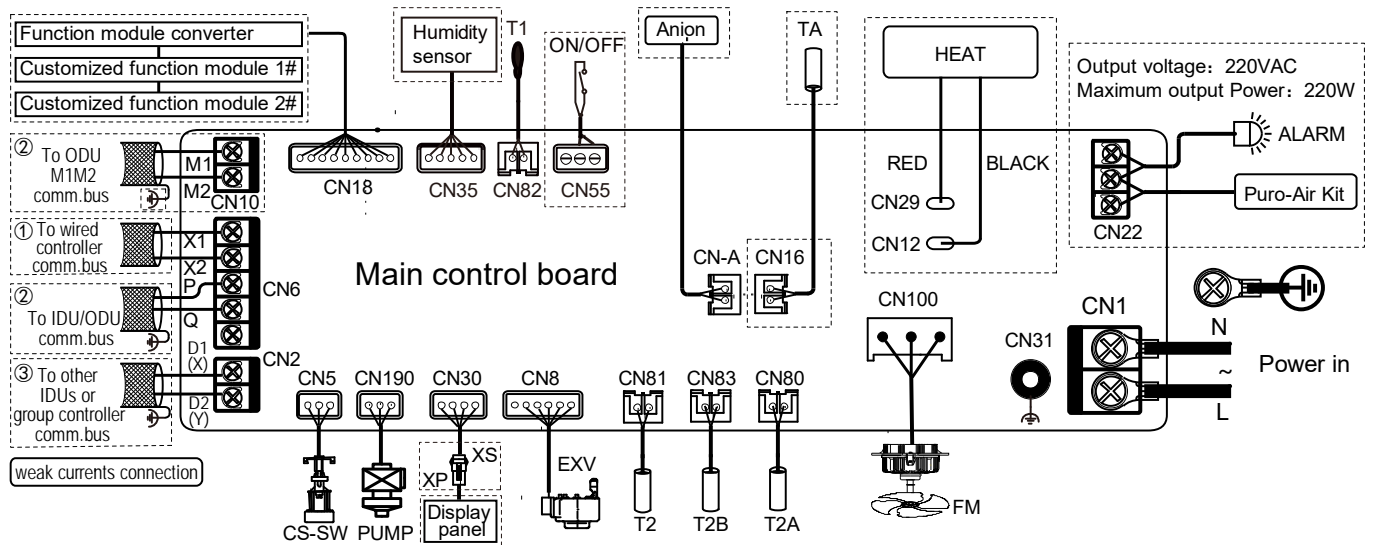

### Notes for installers and service engineers

#### Caution

- All installation, servicing and maintenance must be carried out by competent and suitably qualified, certified and accredited professionals and in accordance with all applicable legislation.
- Units should be grounded in accordance with all applicable legislation. Metal and other conductive components should be insulated in accordance with all applicable legislation.
- Power supply wiring should be securely fastened at the power supply terminals – loose power supply wiring would represent a fire risk.
- After installation, servicing or maintenance, the electric control box cover should be closed. Failing to close the electric control box cover risks fire or electric shock.
- The dotted lines indicate the field wiring or optional function.
- PQ and M1M2 communication ports both are used for indoor and outdoor communication, and only one of them can be used at a time. Meanwhile, be sure to connect the same communication ports (PQ to PQ; M1M2 to M1M2) in case of damage of the main control board.
- D1D2 communication ports are used for group control communication. When connecting the group controller, the D1D2 port of the indoor units that are to be group controlled must be connected in daisy chain, and the group controller must be connected to the X1X2 port of one of the indoor units in the group control, and set to group control mode. In addition, D1D2 communication ports can also be connected to the central controller.



## 6 Capacity Tables

### 6.1 Cooling Capacity Table

Table 6.1: Compact Four-way Cassette cooling capacity

Model	Indoor air temperature (°C WB/DB)													
	14/20		16/23		18/26		19/27		20/28		22/30		24/32	
	TC	SC	TC	SC	TC	SC	TC	SC	TC	SC	TC	SC	TC	SC
MIH15Q4CHN18	1.4	1.4	1.5	1.5	1.5	1.4	1.5	1.3	1.6	1.3	1.6	1.2	1.6	1.1
MIH22Q4CHN18	2.0	2.0	2.1	2.1	2.2	2.0	2.2	1.9	2.3	1.9	2.3	1.8	2.4	1.7
MIH28Q4CHN18	2.5	2.5	2.7	2.7	2.8	2.6	2.8	2.4	2.9	2.4	2.9	2.2	3.0	2.1
MIH36Q4CHN18	3.2	3.2	3.4	3.2	3.6	3.2	3.6	3.0	3.7	3.0	3.8	2.8	3.9	2.7
MIH45Q4CHN18	4.0	4.0	4.3	4.1	4.5	4.0	4.5	3.8	4.6	3.7	4.7	3.5	4.8	3.3
MIH56Q4CHN18	5.0	4.9	5.3	4.9	5.6	4.9	5.6	4.6	5.7	4.5	5.8	4.3	6.0	4.1
MIH63Q4CHN18	5.6	5.5	6.0	5.6	6.3	5.5	6.3	5.2	6.4	5.1	6.6	4.9	6.7	4.6

Abbreviations:

TC: Total capacity (kW)

SC: Sensible capacity(kW)

Notes:

1. Shaded cells indicate rating condition.

### 6.2 Heating Capacity Table

Table 6.2: Compact Four-way Cassette heating capacity

Model	Indoor air temperature (°C DB)					
	16	18	20	21	22	24
	TC	TC	TC	TC	TC	TC
MIH15Q4CHN18	1.8	1.8	1.7	1.6	1.6	1.5
MIH22Q4CHN18	2.6	2.6	2.4	2.3	2.3	2.1
MIH28Q4CHN18	3.4	3.4	3.2	3.1	3.0	2.8
MIH36Q4CHN18	4.2	4.2	4.0	3.8	3.8	3.5
MIH45Q4CHN18	5.3	5.3	5.0	4.8	4.7	4.4
MIH56Q4CHN18	6.7	6.6	6.3	6.1	5.9	5.5
MIH63Q4CHN18	7.5	7.5	7.1	6.9	6.7	6.2

Abbreviations:

TC: Total capacity (kW)

Notes:

1. Shaded cells indicate rating condition.

## 7 Electrical Characteristics

Table 7.1: Compact Four-way Cassette electrical characteristics

Model name	Power supply						Indoor fan motors	
	Hz	Volts	Min. volts	Max. volts	MCA	MFA	Rated motor output (kW)	FLA
MIH15Q4CHN18	50/60	220-240	198	264	0.46	15	0.045	0.37
MIH22Q4CHN18	50/60	220-240	198	264	0.46	15	0.045	0.37
MIH28Q4CHN18	50/60	220-240	198	264	0.54	15	0.045	0.43
MIH36Q4CHN18	50/60	220-240	198	264	0.54	15	0.045	0.43
MIH45Q4CHN18	50/60	220-240	198	264	0.61	15	0.045	0.49
MIH56Q4CHN18	50/60	220-240	198	264	0.65	15	0.045	0.52
MIH63Q4CHN18	50/60	220-240	198	264	0.81	15	0.045	0.65

Abbreviations:

MCA: Minimum Circuit Amps

MFA: Maximum Fuse Amps

FLA: Full Load Amps

## 8 Sound Levels

### 8.1 Overall

Table 8.1: Compact Four-way Cassette sound pressure levels<sup>1</sup>

Model name	Sound pressure levels dB						
	SSH	SH	H	M	L	SL	SSL
MIH15Q4CHN18	29	28	27	27	26	26	25
MIH22Q4CHN18	29	28	27	27	26	26	25
MIH28Q4CHN18	30	29	28	27	26	26	25
MIH36Q4CHN18	31	30	29	28	27	26	25.5
MIH45Q4CHN18	36.5	35	33	31	29	28	26.5
MIH56Q4CHN18	39	38	37	36	35	34	32
MIH63Q4CHN18	43	42	40	38	36	35	33.5

Notes:

1. Sound pressure levels are measured 1.4m below the unit in a semi-anechoic chamber at 0 Pa static pressure. During in-situ operation, sound pressure levels may be higher as a result of ambient noise.

Figure 8.1: Compact Four-way Cassette sound pressure level measurement

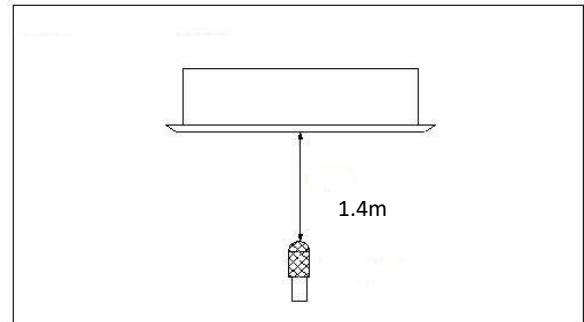

### 8.2 Octave Band Levels

Figure 8.2: MIH15Q4CHN18 octave band levels

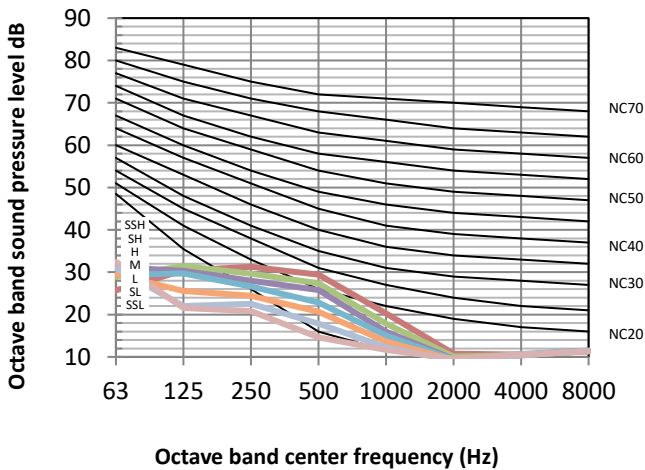

Figure 8.3: MIH22Q4CHN18 octave band levels

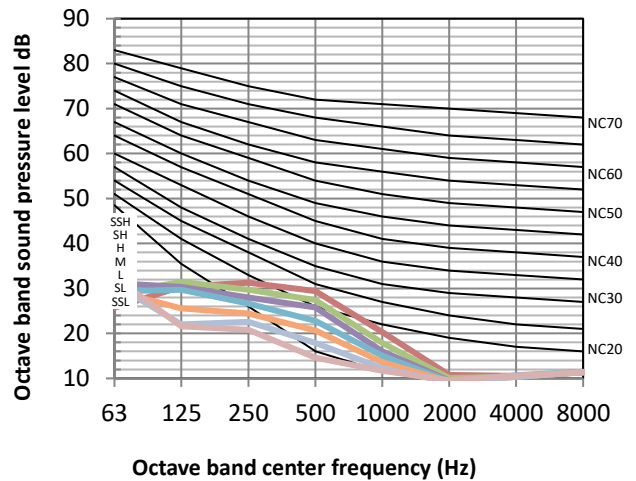

Figure 8.2: MIH28Q4CHN18 octave band levels

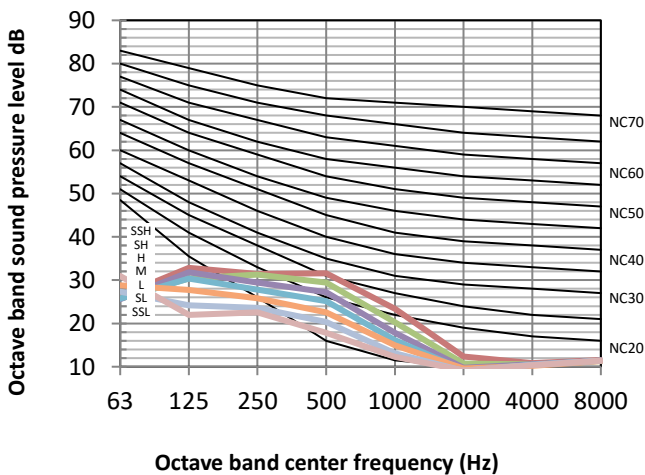

Figure 8.3: MIH36Q4CHN18 octave band levels

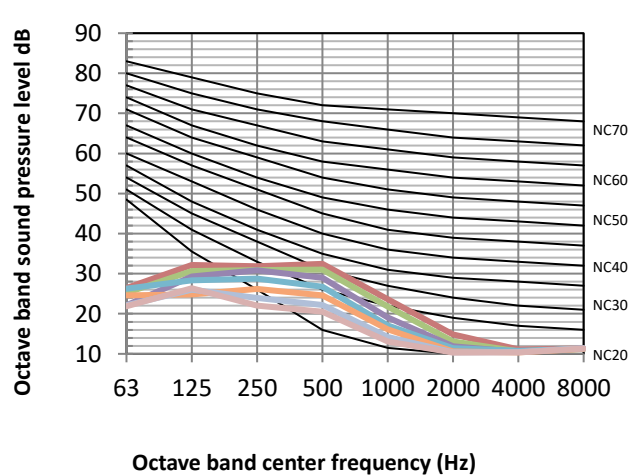

Figure 8.2: MIH45Q4CHN18 octave band levels

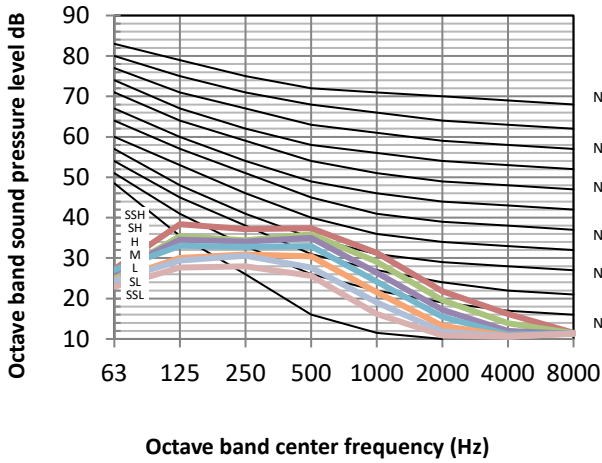

Figure 8.3: MIH56Q4CHN18 octave band levels

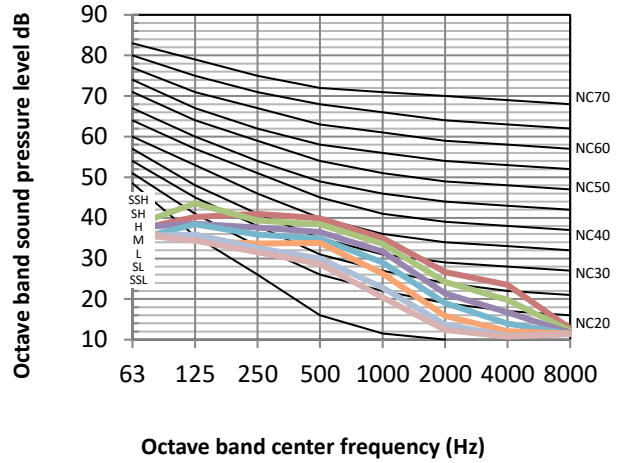
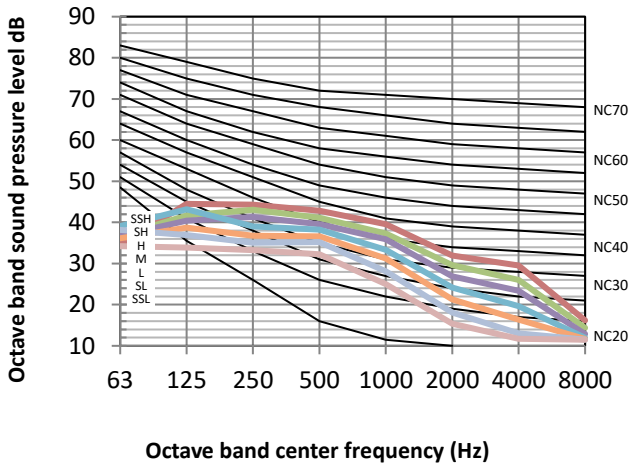

Figure 8.2: MIH63Q4CHN18 octave band levels



## 9 Temperature and Airflow Distributions

### 9.1 Simulate condition

Table 9.1: Compact Four-way Cassette simulate condition

Model name	Room size (m)	Ceiling height (m)	Flow angle (Cooling/Heating)	Placing
MIH15Q4CHN18	5*5	2.7	40° /70°	Center
MIH22Q4CHN18	5*5	2.7	40° /70°	Center
MIH28Q4CHN18	6*6	2.7	40° /70°	Center
MIH36Q4CHN18	6*6	2.7	40° /70°	Center
MIH45Q4CHN18	6*6	2.7	40° /70°	Center
MIH56Q4CHN18	6*6	2.7	40° /70°	Center
MIH63Q4CHN18	6*6	2.7	40° /70°	Center

Note:

1. These figures and videos are based on software simulation. They show typical temperature and airflow distributions in the conditions above. In the actual installation, they may differ from these figures and videos under the influence of air temperature conditions, ceiling height, cooling/heating load, obstacles, etc.

### 9.2 Airflow distributions

Figure 9.1: MIH15Q4CHN18 cooling at 300s

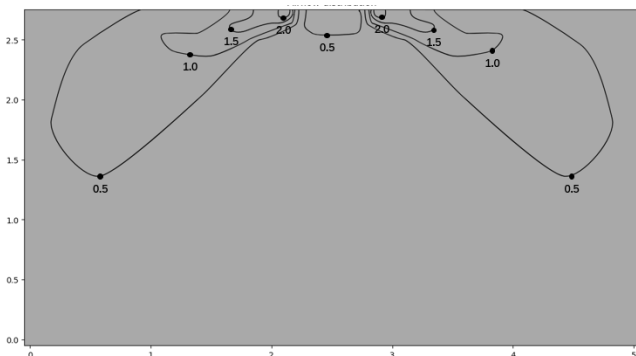

Figure 9.2: MIH15Q4CHN18 heating at 300s

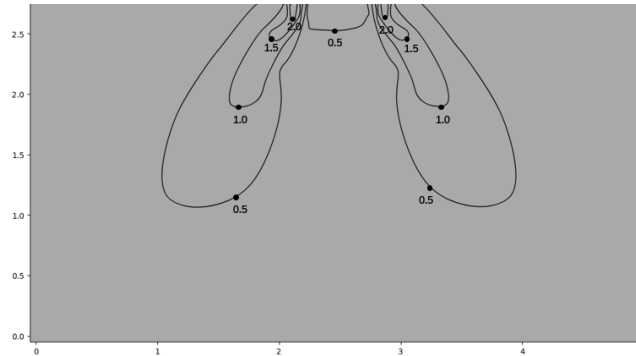

Figure 9.3: MIH22Q4CHN18 cooling at 300s

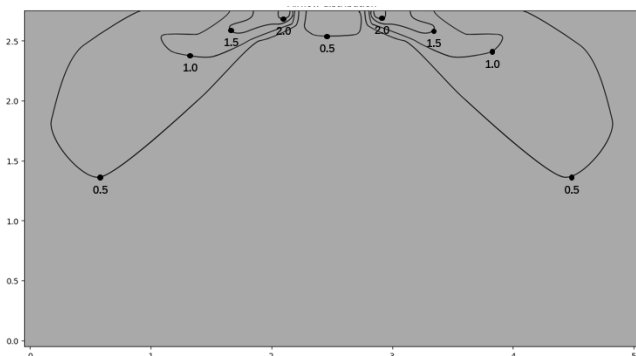

Figure 9.4: MIH22Q4CHN18 heating at 300s

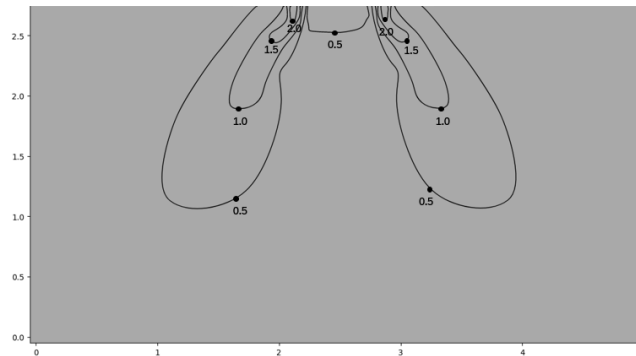

Figure 9.5: MIH28Q4CHN18 cooling at 300s

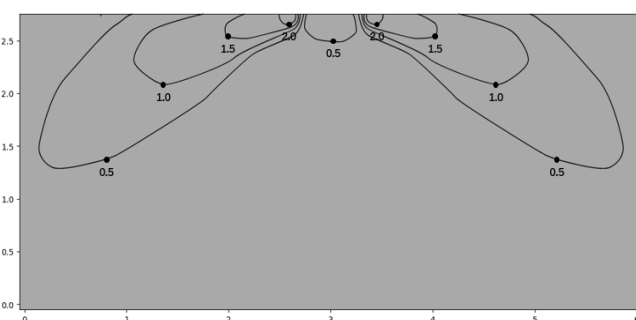

Figure 9.6: MIH28Q4CHN18 heating at 300s

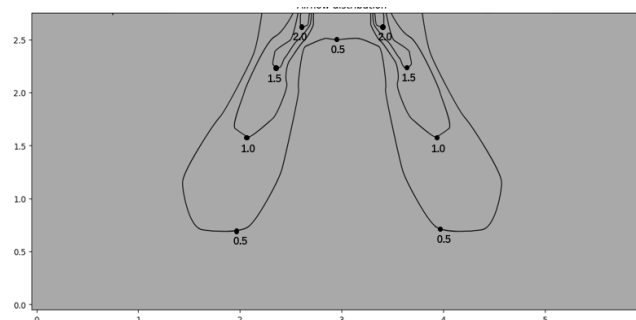

Figure 9.7: MIH36Q4CHN18 cooling at 300s

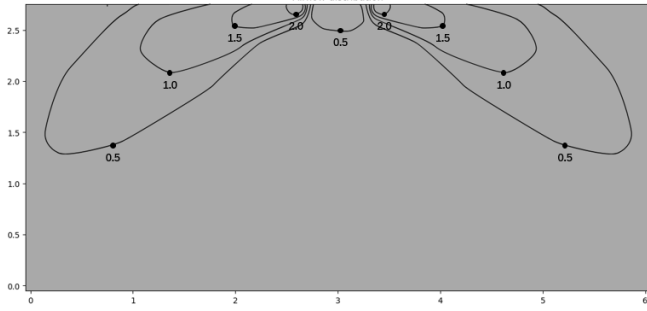

Figure 9.9: MIH45Q4CHN18 cooling at 300s

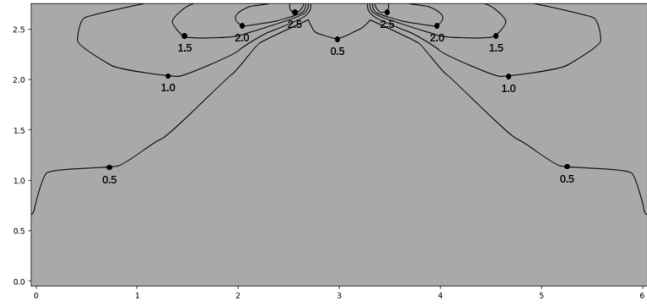

Figure 9.11: MIH56Q4CHN18 cooling at 300s

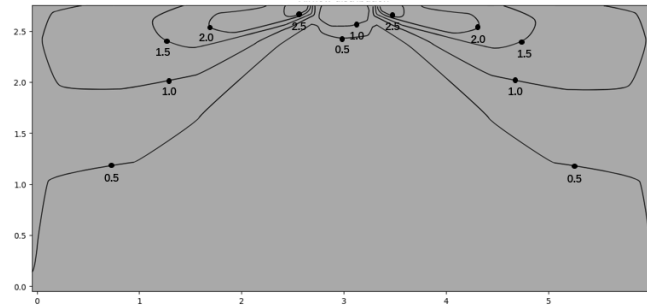

Figure 9.13: MIH63Q4CHN18 cooling at 300s

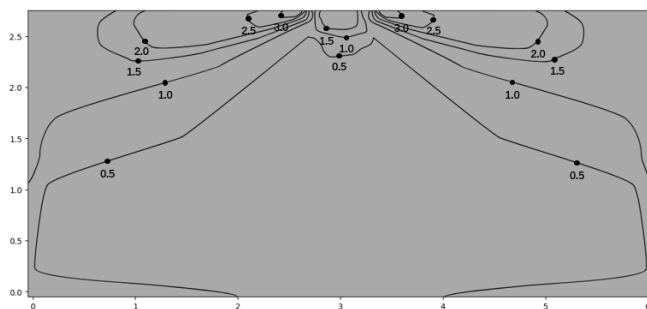

Figure 9.8: MIH36Q4CHN18 heating at 300s

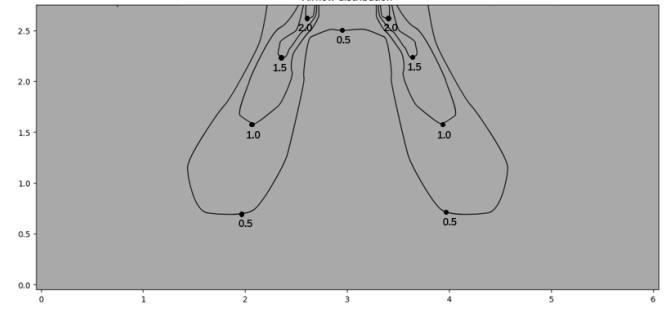

Figure 9.10: MIH45Q4CHN18 heating at 300s

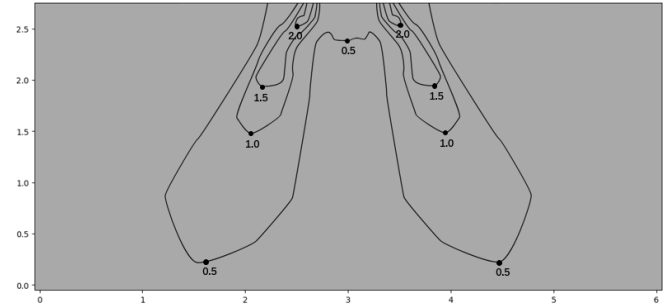

Figure 9.12: MIH56Q4CHN18 heating at 300s

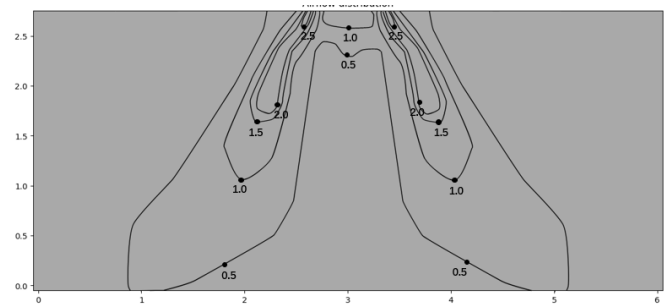
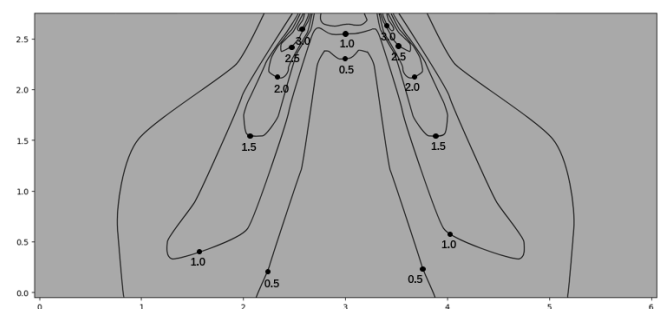

Figure 9.14: MIH63Q4CHN18 heating at 300s



## 9.3 Temperature distributions

Figure 9.1: MIH15Q4CHN18 cooling at 300s

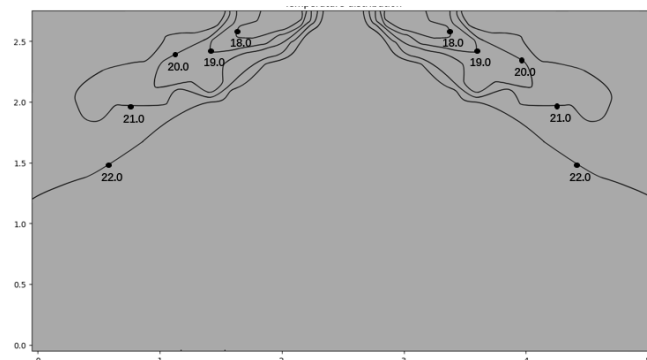

Figure 9.2: MIH15Q4CHN18 heating at 300s

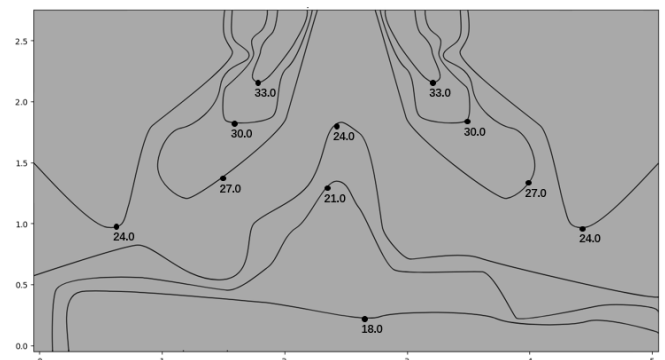

Figure 9.3: MIH22Q4CHN18 cooling at 300s

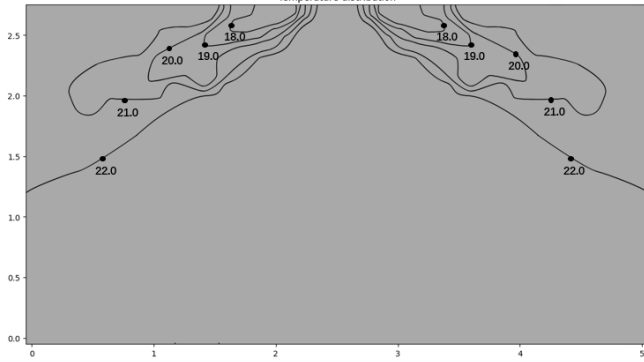

Figure 9.4: MIH22Q4CHN18 heating at 300s

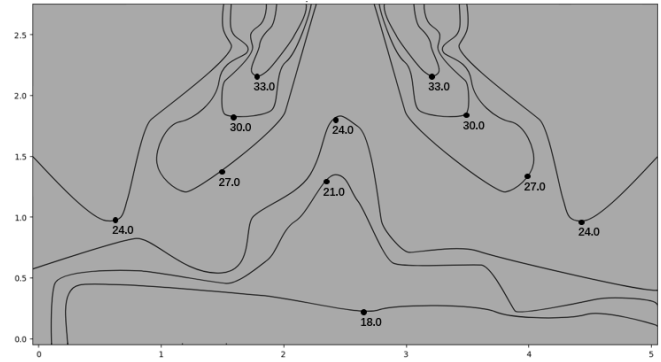

Figure 9.5: MIH28Q4CHN18 cooling at 300s

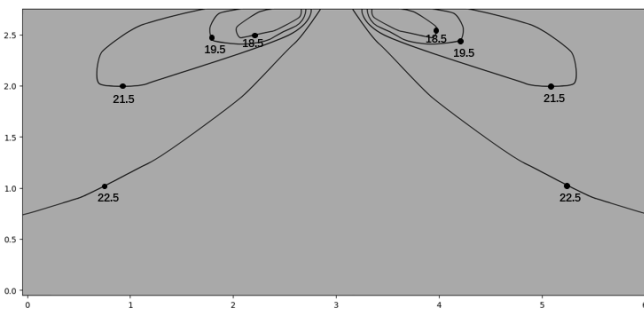

Figure 9.6: MIH28Q4CHN18 heating at 300s

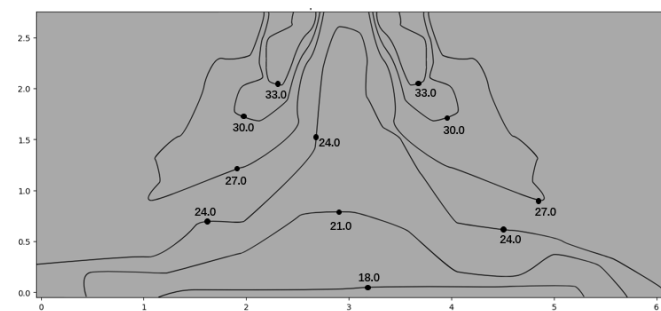

Figure 9.7: MIH36Q4CHN18 cooling at 300s

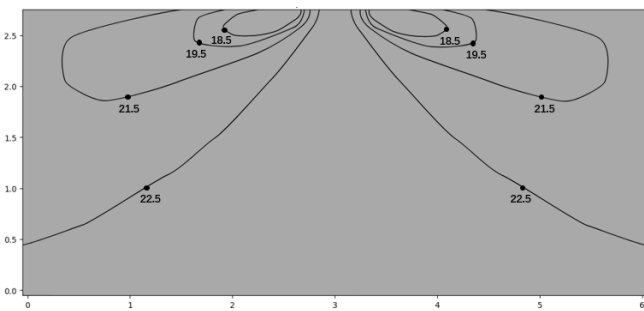

Figure 9.8: MIH36Q4CHN18 heating at 300s

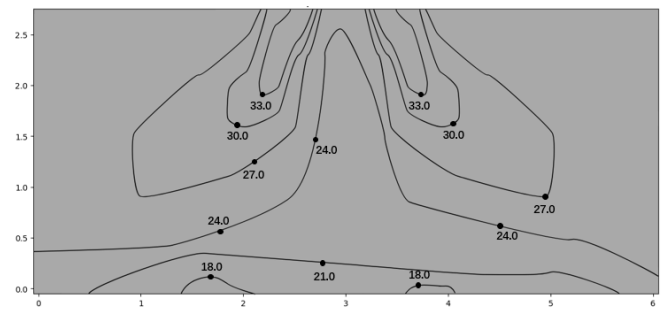

Figure 9.9: MIH45Q4CHN18 cooling at 300s

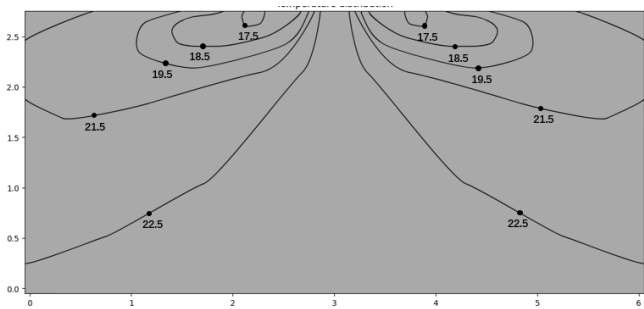

Figure 9.10: MIH45Q4CHN18 heating at 300s

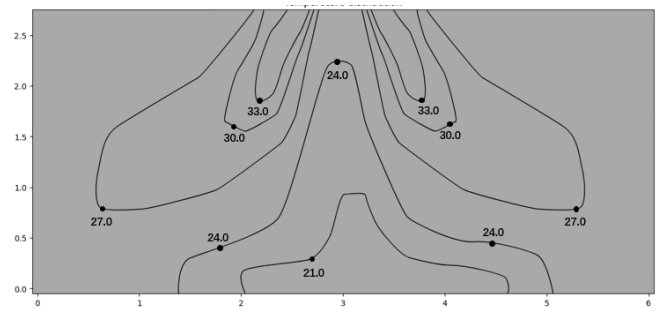

Figure 9.11: MIH56Q4CHN18 cooling at 300s

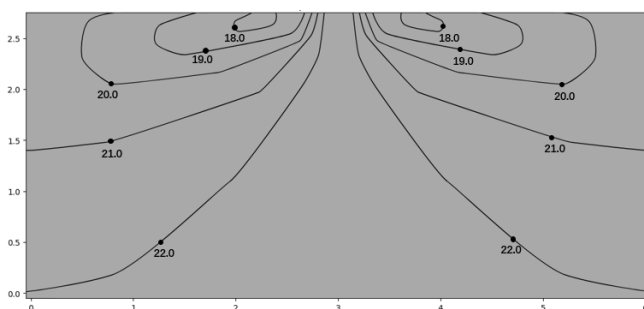

Figure 9.12: MIH56Q4CHN18 heating at 300s

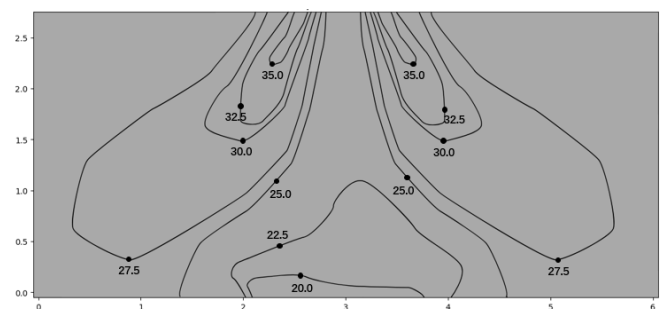

Figure 9.13: MIH63Q4CHN18 cooling at 300s

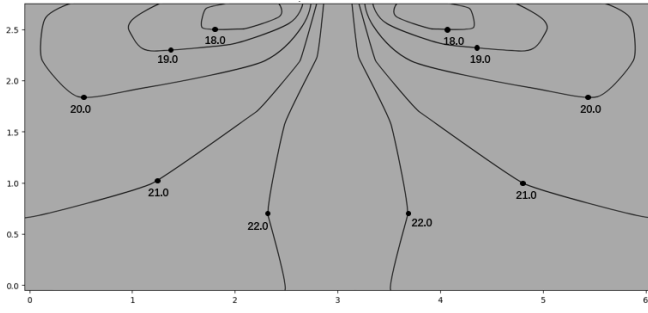
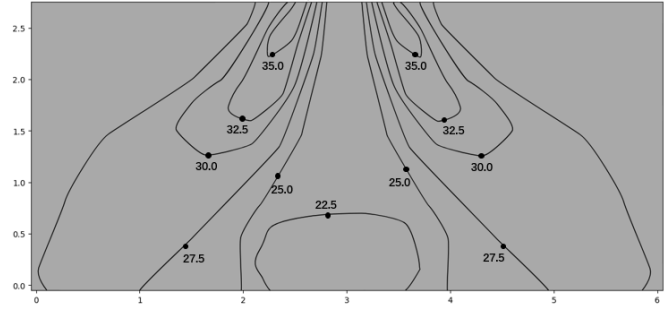

Figure 9.14: MIH63Q4CHN18 heating at 300s





**Midea Building Technologies Division**  
**Midea Group**

**Add.:** Midea Headquarters Building, 6 Midea Avenue, Shunde, Foshan, Guangdong, China

**Postal code:** 528311

mbt.midea.com / [www.midea-group.com](http://www.midea-group.com)



Note: Product specifications change from time to time as product improvements and developments are released and may vary from those in this document.